

ORDERING INFORMATION

Order code: 63887
 Description: LPDL4/RND/9W/40K/SLV/STD
 UPC: 69549638877
 Case quantity: 24

PERFORMANCE DATA

Shape:	Round
Size and type:	LED Low Profile Downlight 4"
Lens type:	Acrylic
Lens finish:	Frosted
Hole cutting:	4 ³ / ₁₆ in (106mm)
Finish colour:	Brushed Nickel
Size:	4 ³ / ₄ in (120.5 mm)
Wattage (W):	9
Voltage (VAC):	120
Beam angle:	120°
IP Rating:	42
THD:	40%
Power factor:	>0.9
CBCP:	220
CRI:	80
Color temperature (K)**:	4 000
Average life (hours):	40 000
Initial lumens (lm)*:	550
Initial lumens per watt (lm/W):	67
Operating temperature range:	- 20 °C / - 4 °F to 45 °C / 113 °F

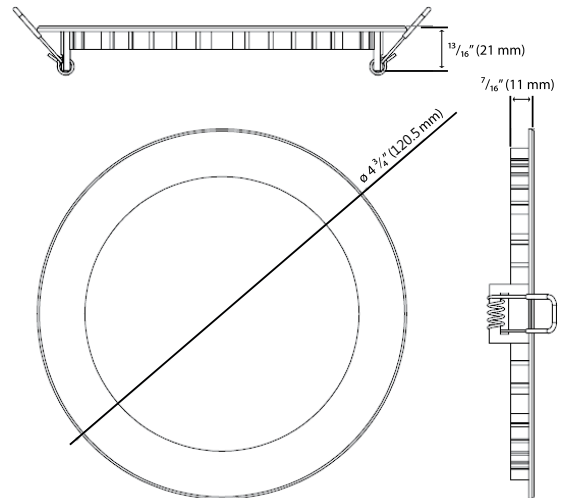

*Initial lumens range: +/- 5 %

**Typical colour temperature range: +/- 5 %

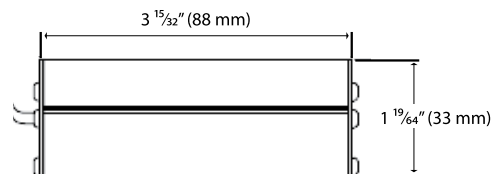
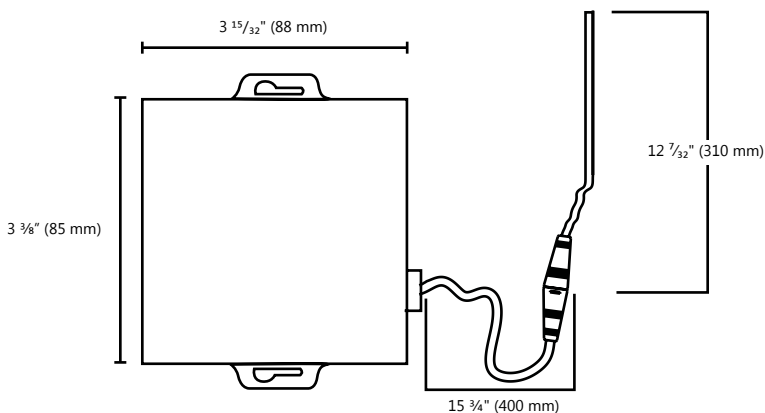

For a complete list of ENERGY STAR qualified products, please visit www.standardpro.com

Data is based upon tests performed in a controlled environment and representative of relative performance. Actual performance can vary depending on operating conditions. Specifications are subject to change without notice.

December 2, 2015

PHOTOMETRY

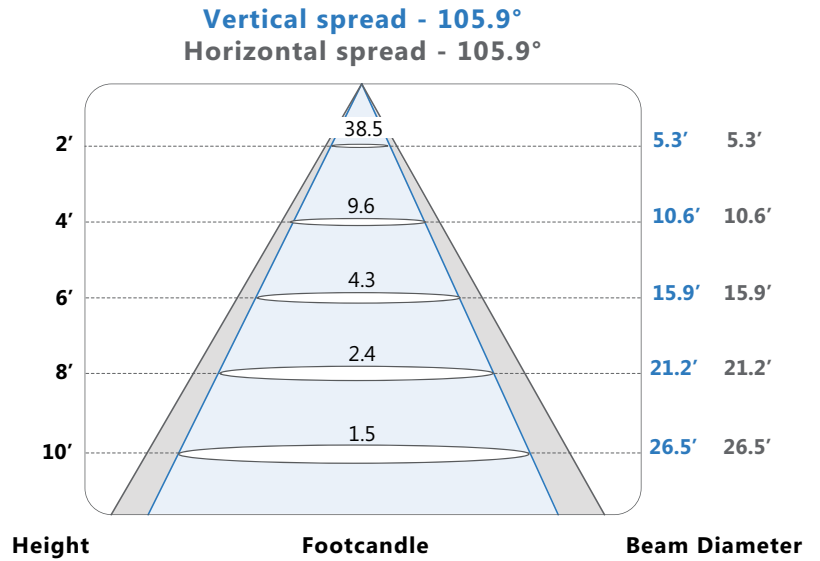
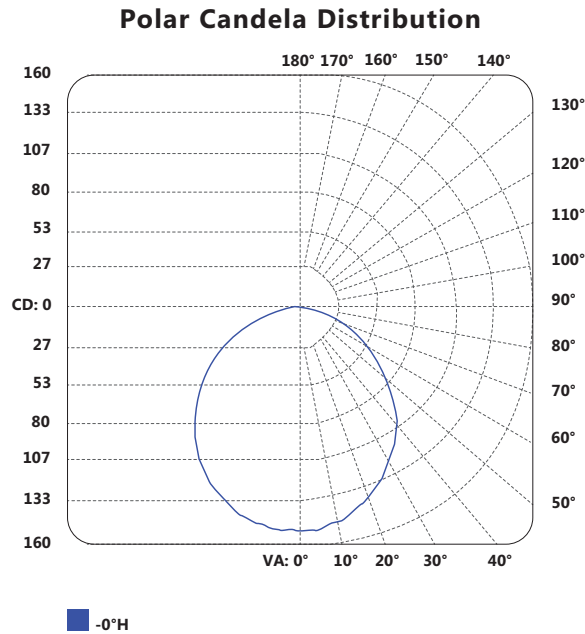

COMPATIBLE DIMMER LIST

Brand:	Model
Legrand:	H703PTUW, HCL453P
Cooper:	DAL06P, SAL06P, SLC03P, AAL06
Leviton:	IPL06, 6674, DSM10-1LZ
Lutron:	DVCL-153P, CTCL-153P, MACL-153P, AYCL-253P, DVCL-253P

*NOTE: The above table shows dimmers that have been tested and have demonstrated proper operation under normal conditions. Each installation being unique, various factors such as load, common neutrals or other electrical products on the circuit can, in certain instances, cause variance in system performance. Read and comply to the dimmer installation instructions. Consult dimming system manufacturer for additional support in operation. Standard recommends to use dimmers designed to work with LED products. Older dimmers designed for incandescent products may cause erratic operation. Do not mix products of different wattages or types on the same dimming circuit. Some dimmers may require more than one product for stable operation. The maximum number of products is determined by the dimmer wattage rating with LEDs. Be careful, these dimmers have different ratings depending on the product type. Again, refer to the dimmer installation instructions. For example, if the dimmer rating is 150W with LED, a user may use up to sixteen (16) 9W LPDL.